

# HIZERO®

4-in-1 Bionic Mop (F801)

User Manual

F8P-USG03

[www.hizero.com](http://www.hizero.com)



Bring the  
World into  
Bionic  
Cleaning Era

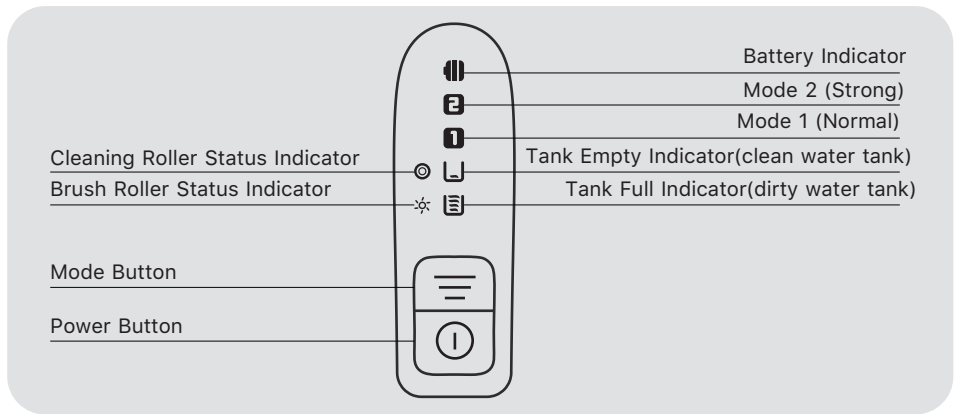

## Charging



**Flashing in red:** Appliance is charging

**Lighting up in blue:** Appliance is fully charged

## In Service



**Lighting up in red:** Low battery. The appliance can only operate for 10-15 minutes and will automatically switch-off once the battery runs out.

**Lighting up in blue:** Battery capacity is still good.



**Mode 2:** Strong mode, meaning more water consumption for self-cleaning. A full tank of clean water can be used for approximately 5 minutes.



**Mode 1:** Normal mode, meaning less water consumption for self-cleaning. A full tank of clean water can be used for approximately 10 minutes.



**Flashing:** Clean water tank is short of water. The appliance will stop working and automatically switch-off after 30 seconds.

**Lighting up continuously:** The appliance is not functioning properly. Please contact after-sales service.



**Flashing:** A. Dirty water tank may not be placed properly. B. Dirty water tank is full. C. Dirty water sensor is covered by dirt.

The appliance will stop working and automatically switch-off after 10 seconds.

**Lighting up continuously:** The appliance is not functioning properly. Please contact after-sales service.



**Flashing:** Cleaning roller is jammed by foreign objects. The appliance will stop working.

**Lighting up continuously:** The cleaning roller has reached the end of its useful life. Please replace it with a new cleaning roller, then long press mode button until the indicator goes out.



**Flashing:** A. Cleaning head cover is not well closed.

B. Brush roller is jammed by foreign objects, the appliance will stop working.

**Lighting up continuously:** The appliance is not functioning properly. Please contact after-sales service.



**Atmosphere lamp shows in blue:** The appliance is in normal operation.

**Atmosphere lamp shows in red:** The appliance is not functioning properly. Please check the display panel for indication.

# Appliance View

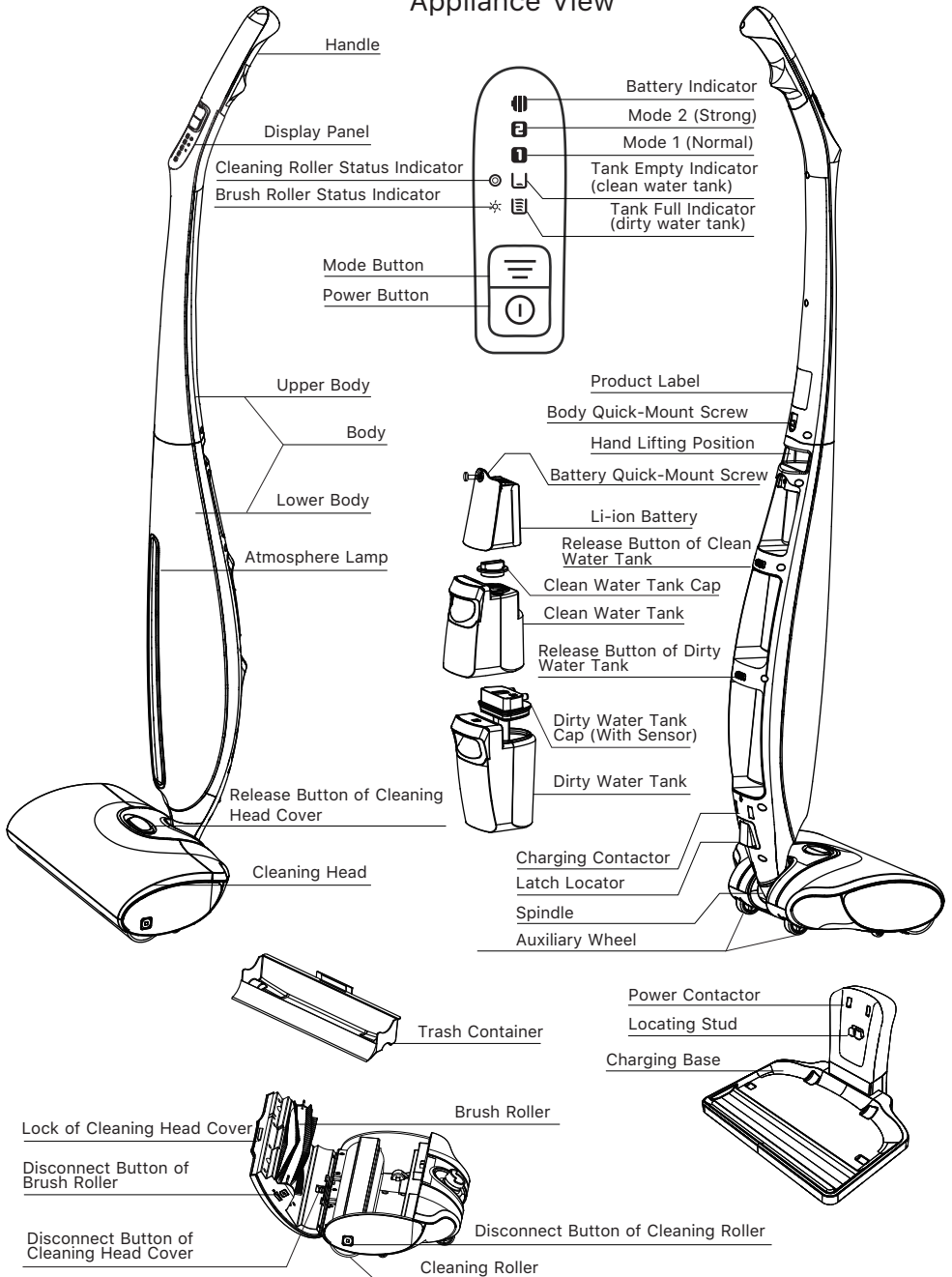

# Table of Contents

1	Introduction	4
1.1	Safety Instructions	4
1.2	Technical and Security Specifications	5
1.3	Self-Protection System	5
1.4	Intended Use	5
1.5	Floor Maintenance	5
2	Assembling	6
3	Preparation	7
3.1	Charging	7
3.2	Removing Loose Objects	7
3.3	Filling the Clean Water Tank	7
3.4	Locking the Body	8
4	Operation	8
4.1	Releasing the Body	8
4.2	Start Cleaning	9
4.3	Tank Full/Tank Empty Indicator	9
4.4	Emptying the Dirty Water Tank	9
4.5	Emptying the Trash Container	10
4.6	Self-Protection System	10
5	Maintenance & Cleaning	11
5.1	Maintenance	11
5.2	Cleaning the Water Tanks	11
5.3	Cleaning the Brush Roller	11
5.4	Cleaning the Cleaning Roller	11
5.5	Cleaning the Trash Container	12
5.6	Cleaning the Cleaning Head Cover	12
6	Storing & Moving	12
6.1	Storing	12
6.2	Moving	12
7	Replacing	13
7.1	Replacing the Brush Roller	13
7.2	Replacing the Cleaning Roller	13
8	Ordering Accessories	14
9	Caring for the Environment	14
10	Warranty & Service	14
11	Troubleshooting	15

## 1 Introduction

Thank you for choosing HIZERO 4-in-1 Bionic Mop!

HIZERO 4-in-1 Bionic Mop is an intelligent floor cleaning machine based on innovative bionic technology, which perfectly integrates the functions of sweeping, mopping, drying and self-cleaning. Its advent is honored as "The Second Revolution in Floor Cleaning Field". The appliance equipped with built-in rechargeable battery, is able to separate solid trash from dirty water, and automatically self-clean during operation. After use, all that needed is to discard the disposable trash tray and empty the dirty water tank. It is featured by extremely high cleaning efficiency, simple operation and easy maintenance.

In this user manual, we will give you some tips to make the cleaning job as easy and efficient as possible. We hope that you enjoy using this appliance as much as we enjoyed creating it.

Please read this user manual carefully before you use the appliance and save it for further reference.

### 1.1 Safety Instructions

#### 1.1.1 Danger

- To prevent electric shock, never move the appliance over any kind of power socket.
- To prevent electric shocks, never move the appliance over floor or wall sockets, when it is in charging.
- Keep clothing, hair, fingers, and all parts of human body; pet and other obstacle away from the cleaning roller and openings in front of cleaning head.

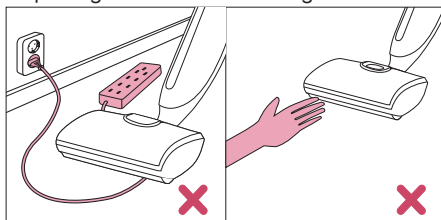

#### 1.1.2 Caution

- The appliance must be removed from the charging base before cleaning or maintenance.

- Always switch off the appliance before you remove water tanks or open the cleaning head cover.
- To avoid a hazard, do not let the appliance pick up sharp objects.
- To avoid any damage, never immerse the body of the appliance in water or any other liquid, nor rinse it under the tap.
- Never use this appliance to pick up flammable or combustible liquids and do not put flammable or combustible liquids in the clean water tank.
- Regularly check the appliance and involved parts, do not use them if the appliance or the charging base is damaged. You must have it maintained or replaced by an authorized service center.

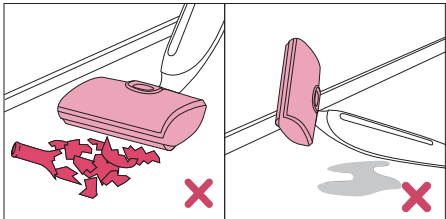

- This appliance is not intended for use by persons (including children) with reduced physical, sensory or mental capabilities, or lack of experience and knowledge, unless they have been given supervision or instruction concerning use of the appliance by a person responsible for their safety.
- Children should be supervised to ensure that they do not play with the appliance.
- Never store the appliance at a temperature lower than 0°C/32°F.
- Never put acetic acid (vinegar) or a descaler in the clean water tank or use the appliance to pick them up.
- Never put wax, oil or floor maintenance products that cannot be diluted in the clean water tank, nor use the appliance to pick them up.
- Never use the battery for other purposes other than this appliance, and never expose it to heat (50°C/122°F), outdoor or wet conditions.
- When removing the battery, keep the terminals away from other metal objects like paper clips, keys, nails, screws etc., to avoid any thermal effect, smoke, burn or even explosion.
- Use only HIZERO cleaning authorized solution intended for use with this appliance to prevent internal component damage.
- Never clean the cleaning roller with a sharp object, as this may damage the roller and reduce the cleaning performance.
- To prevent leakage, never put the appliance on its side or upside down when the water tank contains water .

## 1.2 Technical and Security Specifications

This appliance complies with the current recognized electrical product technical specifications and safety regulations. If handled properly according to the instructions in this user manual, the appliance is safe to use.

## 1.3 Self-Protection System

This appliance is equipped with active protection system. If large object, like towel or curtain is adsorbed, the appliance will stop working and show an indication to prevent damage.

## 1.4 Intended Use

This appliance is used exclusively for cleaning hard floors only (e.g. tile/marble/wooden floor and all water-resistant floors). Do not use this appliance to clean carpet or other floor that is water-sensitive.

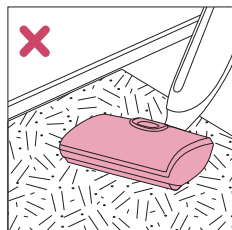

**Note:** Do not use this appliance for carpet.

## 1.5 Floor Maintenance

Always follow the maintenance instructions of your hard floor when you use this appliance.

HIZERO cleaning solution can be used to strengthen cleaning effects. Do not add any unauthorized floor-care product into the water tank.

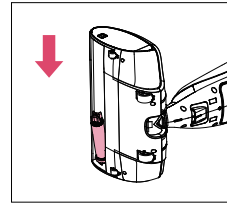
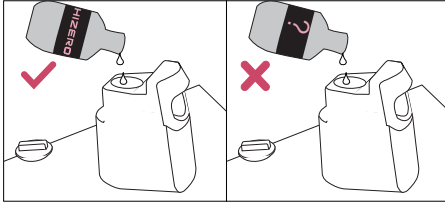

- 4 Insert the cleaning roller onto the motor (note: the maximum open angle of the drive motor is 45°), push and fix it into the cleaning head till the lateral button in place.

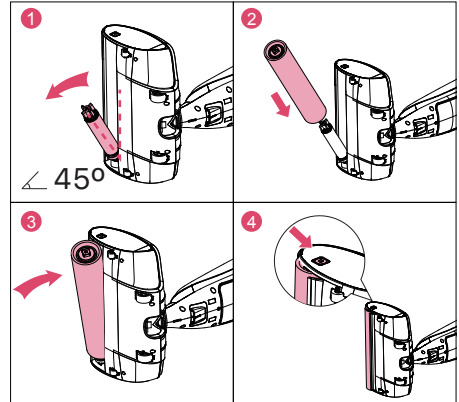

## 2 Assembling

- 1 Open the packing box and take out the cleaning roller. Please immerse it in 40 °C/104°F warm water for two minutes to make it soft before first use (the water temperature should not be higher than 50 °C/122°F; if in cold water, please immerse it for above ten minutes).

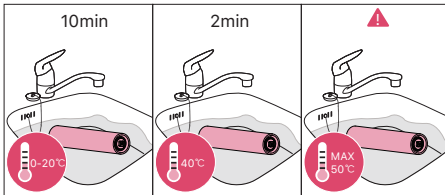

- 2 Take out the lower body of the appliance, press the release button of the cleaning head cover to open the cover, then take out the trash container.

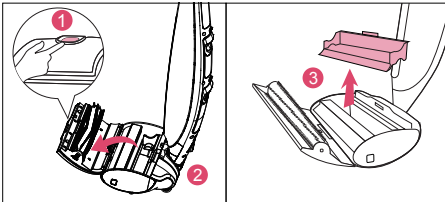

- 3 Close the cleaning head cover, put the body on its side on flat ground to upturn the disconnect button of the cleaning roller.

- 5 Place the lower body in upright position, open the cleaning head cover, insert the trash container and press it into place, then place a disposable trash tray. Close the cover until you hear a click, the cover is locked.

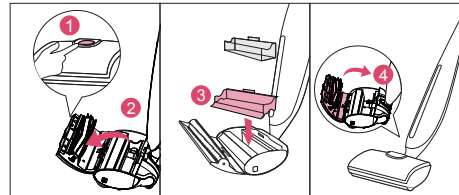

- 6 Push the lower body forward lightly until you hear a click to lock it in parking position.

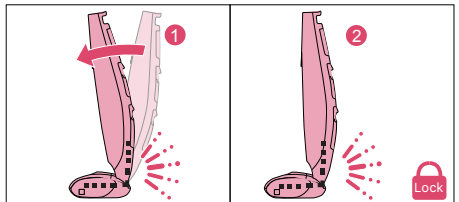

- 7 Take out the upper body of the appliance and remove the body quick-mount screw first. Connect the flat cables in upper and lower bodies.

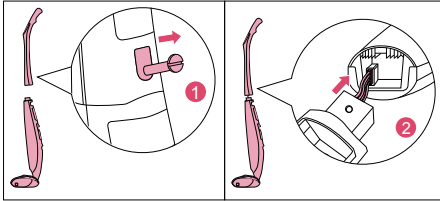

**Note:** Please flip to the other side of cable and try to connect again if the snap joint doesn't fit.

- 8 Insert and tighten the quick-mount screw with a coin or screwdriver to make the upper and lower body fit together exactly.

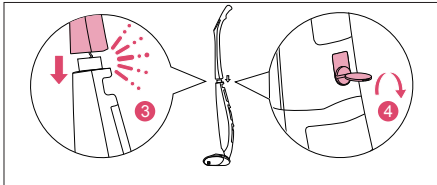

- 9 Insert the battery into battery compartment on the lower body and tighten the screw

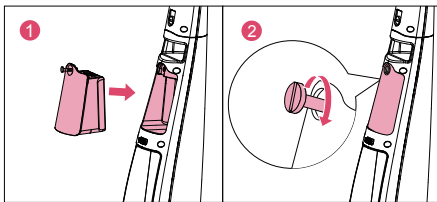

- 10 Assemble the charging base, insert the foot pads into the hole on the bottom of the charging base. Connect the power adapter, the excess power line can be stored in the cable slot.

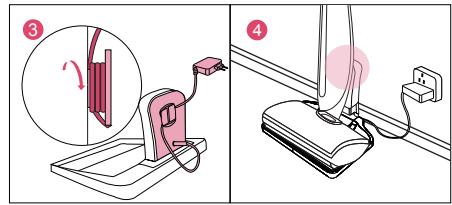
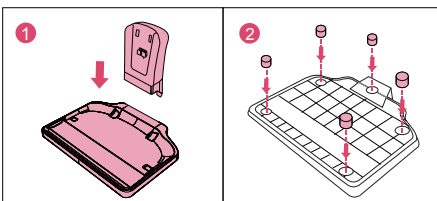

## 3 Preparation

### 3.1 Charging

- 1 Make sure the charging base and power adapter are well connected, plug the appliance into a properly grounded outlet.
- 2 Place the appliance on the charging base and clasp the latch locator onto the locating stud. The charging indicator will flash in red to indicate the appliance is charging.
- 3 Before first use, please charge the appliance. When the battery runs out, it requires approximately 4 hours charging to regain full battery capacity.

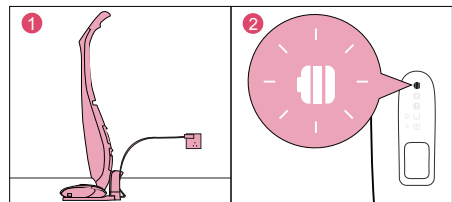

**Note:** For your safety, please keep the charging base in a dry place and do not touch the charge port.

### 3.2 Removing Loose Objects

Before you clean your floor, clear the floor of loose objects such as toys, power cords and shoes.

### 3.3 Filling the Clean Water Tank

Fill the clean water tank before every use. Under Mode 1, a full tank of clean water can be used for about 10 minutes (normally enough to clean a surface area of about 50m<sup>2</sup> /450sqf).

- 1 Press the release button while pulling the clean water tank to take it out. To prevent the appliance from toppling over, hold it upright with one hand and take out the clean water tank with your other hand.

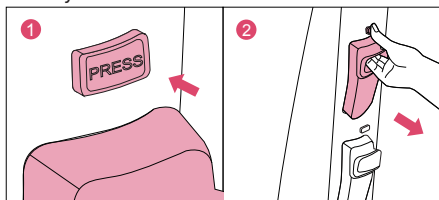

- 2 Turn the cap anticlockwise and remove it from the clean water tank. Fill the clean water tank with cold or warm water (should not be higher than 40°C/104°F). If needed, appropriate detergent may be added (please refer to 1.5 Floor Maintenance).

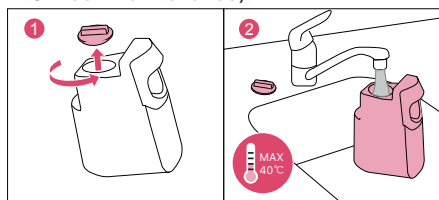

**Note:** If detergent is needed, only environmental friendly detergent authorized by HIZERO is allowed. First add the quantity of detergent indicated on the bottle packing and then fill the clean water tank with water.

- 3 Put back and turn the cap clockwise to fix it. Insert the clean water tank back into the appliance completely until you hear a click, the tank is locked into place. To prevent the appliance from toppling over, hold it upright with one hand and place the clean water tank with your other hand.

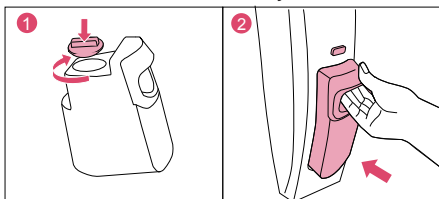

**Note:** To avoid the water tank from creeping down during cleaning, please make sure it is well placed and locked.

### 3.4 Locking the Body

Hold the handle of the appliance, push it forward lightly until you hear a clicking sound, then the appliance is locked in parking position. Don't push it any further, or it will cause the machine to be damaged.

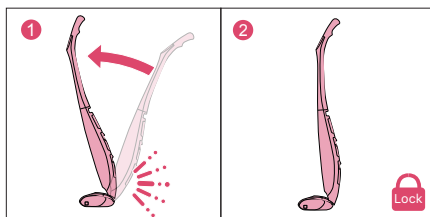

## 4 Operation

### 4.1 Releasing the Body

Lift up the appliance from the charging base, hold the handle and fix the cleaning head with your foot, pull back the body until you hear a clicking sound, then the body is released. Press the power button to start the appliance.



**Note:** During locking and releasing the body, a "clicking" sound is normal.



## 4.2 Start Cleaning

- 1 Make sure the cleaning head can move forward to adsorb trash. If trash is behind the cleaning head, it may not be cleared up.



- 2 Work backwards and in the direction of a door to avoid walking on the mopped floor. The path as shown on the following figures is recommended.

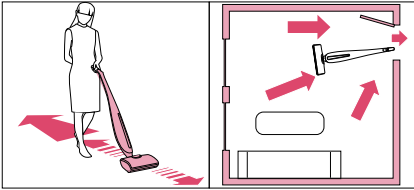

- 3 To remove stains, move the appliance back and forth repeatedly.
- 4 Please do not make the machine fall to the ground.

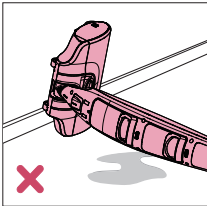

- 5 If there is object adsorbed, please press the power button to switch off the appliance.

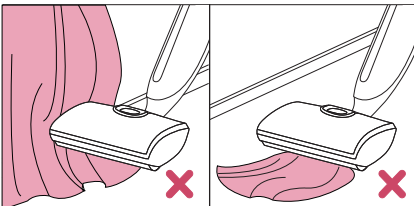

## 4.3 Tank Full/Tank Empty Indicator

- 1 The tank empty indicator starts flashing when the clean water tank is empty. Please switch off the appliance and fill the clean water tank (please refer to 3.3 Filling the Clean Water Tank). Then re-start the appliance.

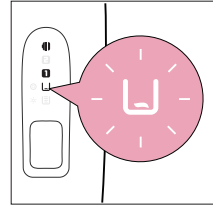

- 2 The tank full indicator starts flashing and the appliance stops operating when the dirty water tank is full. Empty the dirty water tank (please refer to 4.4 Emptying the Dirty Water Tank) and re-start the

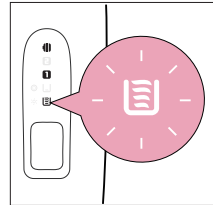

## 4.4 Emptying the Dirty Water Tank

- 1 Press the release button of dirty water tank to take it out. To prevent the appliance from toppling over, hold it upright with one hand and take out the dirty water tank with your other hand.

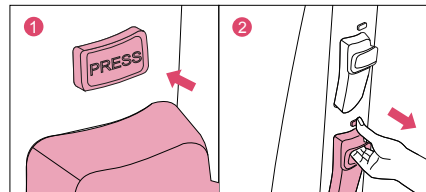

- 2 Remove the cap of dirty water tank, pour the dirty water out, and be careful of water overflow and spilling.

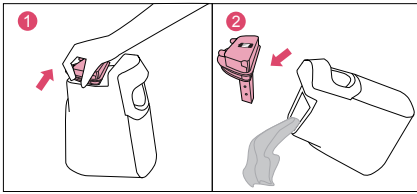

- 3 Rinse the empty dirty water tank and its cap under the tap, wipe dry the metal sensor plate. Then place the tank back into the appliance until you hear a click. To prevent the appliance from toppling over, hold it upright with one hand and place the dirty water tank with your other hand.

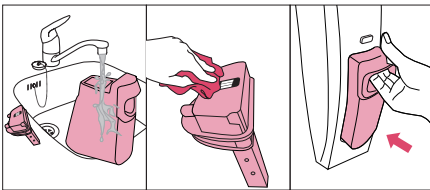

**Note:** To avoid the water tank from creeping down during cleaning, please make sure it is well placed and locked. To avoid any bad connection, please make sure to wipe dry the metal sensor plate.

## 4.5 Emptying the Trash Container

- 1 Open the cleaning head cover, take out the disposable trash tray, throw it away into
- 2 If a disposable trash tray was not used, please take out the trash container, and use the cleaning brush to sweep the trash into a dustbin.

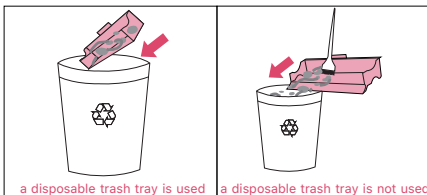

## 4.6 Self-Protection System

The self-protection system has been

designed to recognize abnormal conditions. When the system is activated, the appliance will stop operating immediately to prevent damage to the object and appliance. To continue cleaning, follow the instructions below!

### 4.6.1 Brush Roller Self Protection

Brush roller indicator starts blinking when brush roller doesn't work properly.

- 1 Open the cleaning head cover and remove the jammed object.
- 2 If the jammed object is not easy to find, please disassemble the brush roller to have a better look.
- 3 After clearing obstruction, reinstall the brush roller and re-start the appliance. To disassemble and assemble the brush roller, please refer to 7.1 Replacing the Brush Roller.

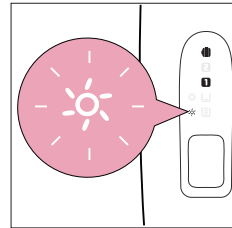

### 4.6.2 Cleaning Roller Self Protection

Cleaning roller indicator starts blinking when cleaning roller doesn't work properly.

- 1 Open the cleaning head cover, take out the trash container and remove the jammed object.
- 2 If the jammed object is not easy to find, please disassemble the cleaning roller to have a better look.
- 3 After clearing obstruction, reinstall the cleaning roller and re-start the appliance. To disassemble and assemble the cleaning roller, please refer to 7.2 Replacing the Cleaning Roller.

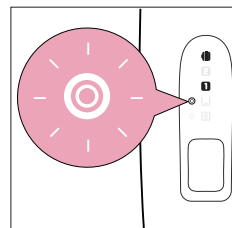

## 5 Maintenance & Cleaning



Note: The appliance must be removed from the charging base and switched off before cleaning or maintaining.

### 5.1 Maintenance

- 1 Regularly clean the outer body of the appliance with a soft damp cloth. Do not use scouring pad or an abrasive cleaning agent to clean the outer body, as this may cause scratches on the surface.
- 2 To avoid any damage, never immerse the body in water or any other liquid, nor rinse it under the tap.
- 3 Regularly check the cleaning roller and brush roller.
- 4 Regularly check the power adapter to ensure the power cable is intact and safe to use.

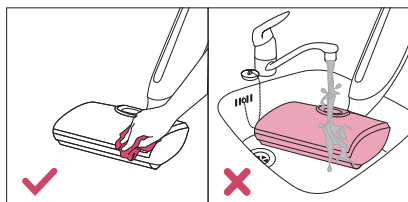

### 5.2 Cleaning the Water Tanks

We strongly advise you to empty the tanks before storing the appliance.

To disassemble and assemble the clean water tank, please refer to 3.3 Filling the Clean Water Tank . The removed clean water tank and cap can be rinsed under the tap. To disassemble and assemble the dirty water tank, please refer to 4.4 Emptying the Dirty Water Tank. The removed dirty water tank and cap can be rinsed under the tap.

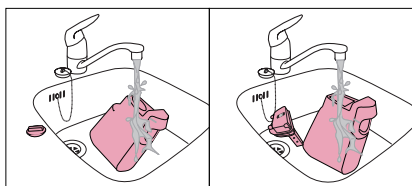

Note: Clean the dirty water tank after every use to prevent the growth of

### 5.3 Cleaning the Brush Roller

- 1 To disassemble and assemble the brush roll, please refer to 7.1 Replacing the Brush Roller.
- 2 Cut off hair and other entanglement on the brush roller and then remove them.
- 3 Clean the brush roller with cleaning solution. Let the brush roller dry before reassembling.

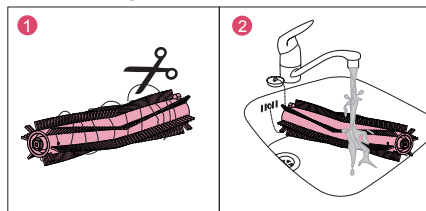

### 5.4 Cleaning the Cleaning Roller

Method 1

- 1 Before cleaning, fill up the clean water tank, add HIZERO cleaning solution if needed, and empty the dirty water tank.
- 2 Make sure the body of the appliance and cleaning head are locked. Start the appliance and switch to Mode 2.
- 3 As per the following figures, hang the cleaning roller above the floor, make the appliance continuously operate in Mode 2 until clean water runs out.
- 4 Steps 1 to 3 could be repeated for two to three times to achieve better cleaning effects.

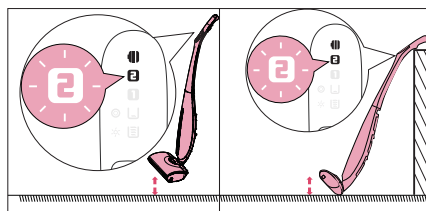

Note: Make sure the appliance won't topple over when hung above the floor.

Method 2

- 1 Refer to 7.2 Replacing the Cleaning Roller to dismantle the cleaning roller for cleaning. Note: empty the dirty water tank before aforementioned steps.

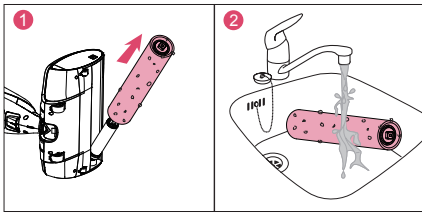

## 5.5 Cleaning the Trash Container

- 1 Take out the trash container, then empty and wash it under the tap. The cleaning brush can be used to sweep off the trash. Let it dry before reassembling.

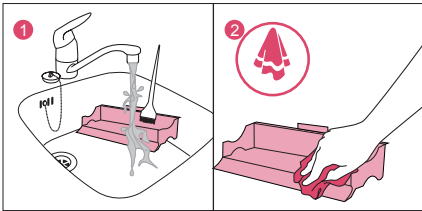

## 5. Cleaning the Cleaning Head Cover

- 1 Open the cleaning head cover, press the release button to take it out, then remove the brush roller.

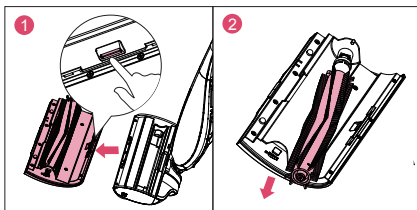

- 2 Clean the cover with a soft damp cloth.



- 3 Reinstall the brush roll into the cover, then fix the cover back to the cleaning head.

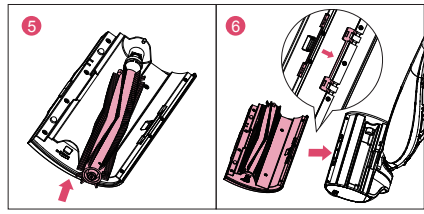

## 6 Storing & Moving

### 6.1 Storing

- 1 Before storage, switch off the appliance, lock the body and place it onto the charging base.
- 2 Please clean the inside of the cleaning head before storing to avoid bacteria breeding.
- 3 Before storage, please make sure the water tanks are empty.
- 4 If the appliance will be out of service for above one week, please unplug the power cord, remove the cleaning roller and store it after drying.

**Note:** Do not store the appliance directly on wooden floor without charging base for a long time to avoid any possible damage of your floor.

### 6.2 Moving

- 1 Make sure the appliance is switched off and locked in upright position.
- 2 You can move and uplift the appliance by the hand lifting position at the appliance's back; or lean it backward, the auxiliary wheels will help for easy moving.

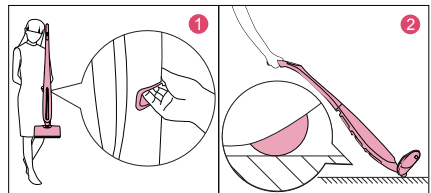

**Note:** If there is sand or sharp object on the floor, do not operate the appliance to avoid any possible scratch.

## 7 Replacing

### 7.1 Replacing the Brush Roller

If you want to continue to benefit from the best cleaning results, make sure you always use original HIZERO brush roller, and we recommend you to replace it every six months.

- 1 Switch off the appliance, lock it in upright position.
- 2 Open the cleaning head cover, press the square buckle at the lateral side to take out the brush roller (Maximum open angle of the drive motor is 30°. Please use appropriate strength and method to avoid any damage).

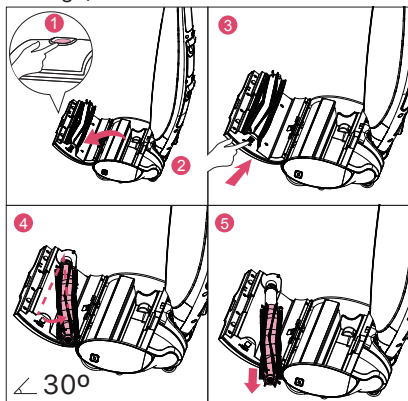

- 3 Insert a new brush roller, close the cover after it is well assembled.

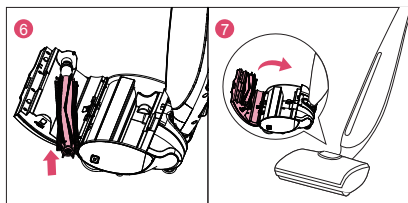

Note: The maximum open angle of the drive motor is 30°. Please operate it carefully.

### 7.2 Replacing the Cleaning Roller

If you want to continue to benefit from the best cleaning results, make sure you always use original IZERO cleaning roller, and replace it every four months.

- 1 Take out the trash container, switch off the appliance, empty or remove the water tanks.
- 2 Put the body on its side on flat ground to upturn the disconnect button of the cleaning roller. Press the lateral disconnect button of the cleaning roller and take it out.

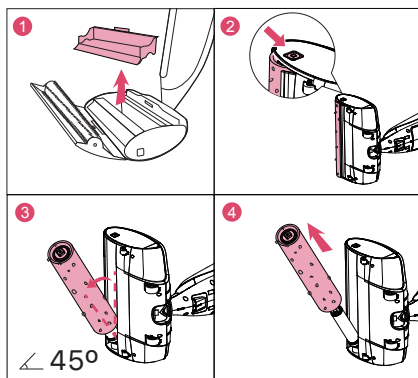

- 3 Insert a new cleaning roller onto the motor, push and fix it into the cleaning head till the lateral button in place. To insert a new cleaning roller, please refer to 2 Assembling.

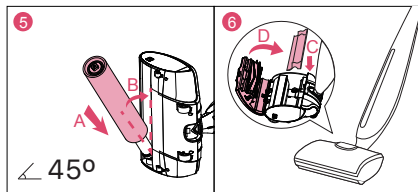

Note: The replaced brush roller and the cleaning roller are plastic waste. Please properly dispose and recycle them according to local environmental protection regulation.

The maximum open angle of the drive motor is 45°, please operate carefully.

---

## 8 Ordering Accessories

---

To purchase accessories for this appliance, please visit our website: [www.hizero.com](http://www.hizero.com), or contact HIZERO Consumer Care Centre in your country.

---

## 9 Caring for the Environment

---

Do not throw away the appliance with the normal household waste at the end of its life, but hand it in at an official collection point for recycling. By doing this, you help to preserve the environment.

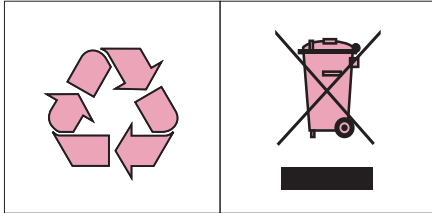

---

## 10 Warranty & Service

---

If you need service or if you have any question, please visit our website: [www.hizero.com](http://www.hizero.com) or contact HIZERO Consumer Care Centre in your country.

Your 4-in-1 Bionic Mop has been designed and developed with the greatest possible care. In the unfortunate case that the appliance needs repair, the Consumer Care Centre in your country will help you by arranging any necessary repairs in the shortest possible time and with maximum convenience.



HIZERO is not liable for all damages caused by improper use or disassembly by customer themselves.

# 11 Troubleshooting

This chapter summarizes the most common problems you could encounter with the appliance. If you are unable to solve the problem with the information below, please contact the Consumer Care Centre in your country or visit our FAQ page on [www.hizero.com](http://www.hizero.com).

Problem	Possible cause	Solution
There is a gap between upper and lower body.	The connection cable is stuck.	Disassemble the upper and lower body, put the connection cable into the line slot. Insert and tighten the quick-mount screw to ensure the upper and lower body fit together exactly.
The wheels cannot move or move with big noise	A. The wheels get jammed.	Remove foreign objects.
	B. The wheels have not been assembled properly.	Adjust the wheels or reassemble them.
Cleaning roller status indicator lights up continuously.	The cleaning roller has reached its useful life.	Please replace it with a new cleaning roller, then long press mode button until the indicator goes out  If a new cleaning roller is not available temporarily, please directly long press mode button until the indicator goes out.
The appliance leaves water on the floor.	The cleaning roller may be broken.	Please check if the cleaning roller is deformation or damaged, if yes, please replace it with a new cleaning roller.
The trash cannot be cleared up when cleaning.	A. The trash container is full.	Empty the trash container.
	B. There are foreign objects at the bottom of the trash container, which causes the trash container not assembled properly.	Remove the foreign objects , replace the trash container and press it into place.
	C. The trash container may be broken.	Replace it with a new trash container.
The appliance fail to boot.	A.The battery runs out.	Charge the appliance and restart it.
	B.The connection cable has not be assembled properly.	Reassemble the cable.
	C.The battery has not be well inserted.	Reinsert the battery.
The tank full indicator doesn't show any indication when the dirty water tank if full.	The dirty water sensor may be broken.	Please contact Consumer Care Centre.
Tank empty indicator lights up continuously.	Appliance may malfunction.	Please contact Consumer Care Centre.
Tank full indicator lights up continuously.	Appliance may malfunction.	Please contact Consumer Care Centre.

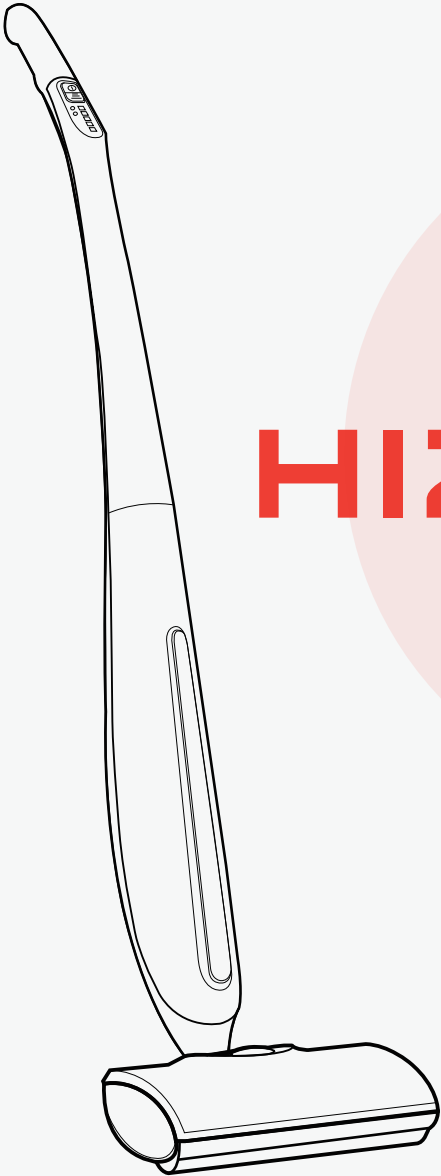

**HIZERO®**

[www.hizero.com](http://www.hizero.com)